

# See. Measure. Automate.

From thru-beam to LiDAR—highly flexible with top performance.

Photoelectric Sensors



Your automation, our passion.

 **PEPPERL+FUCHS**

# Find Your Device in Only a Few Clicks

Go online. Specify your requirements. Select your device. You can find the right solution for your application in just a few clicks. If you have any questions, our experts are available to take your call.

## Online Search on the Pepperl+Fuchs Website

Enter the model number in the search field on the Pepperl+Fuchs website and get to your product selection immediately. Model numbers can be found in this brochure in the technical data summaries. Or you can navigate through our range of product families and groups. Product selectors help you select the optimal device.

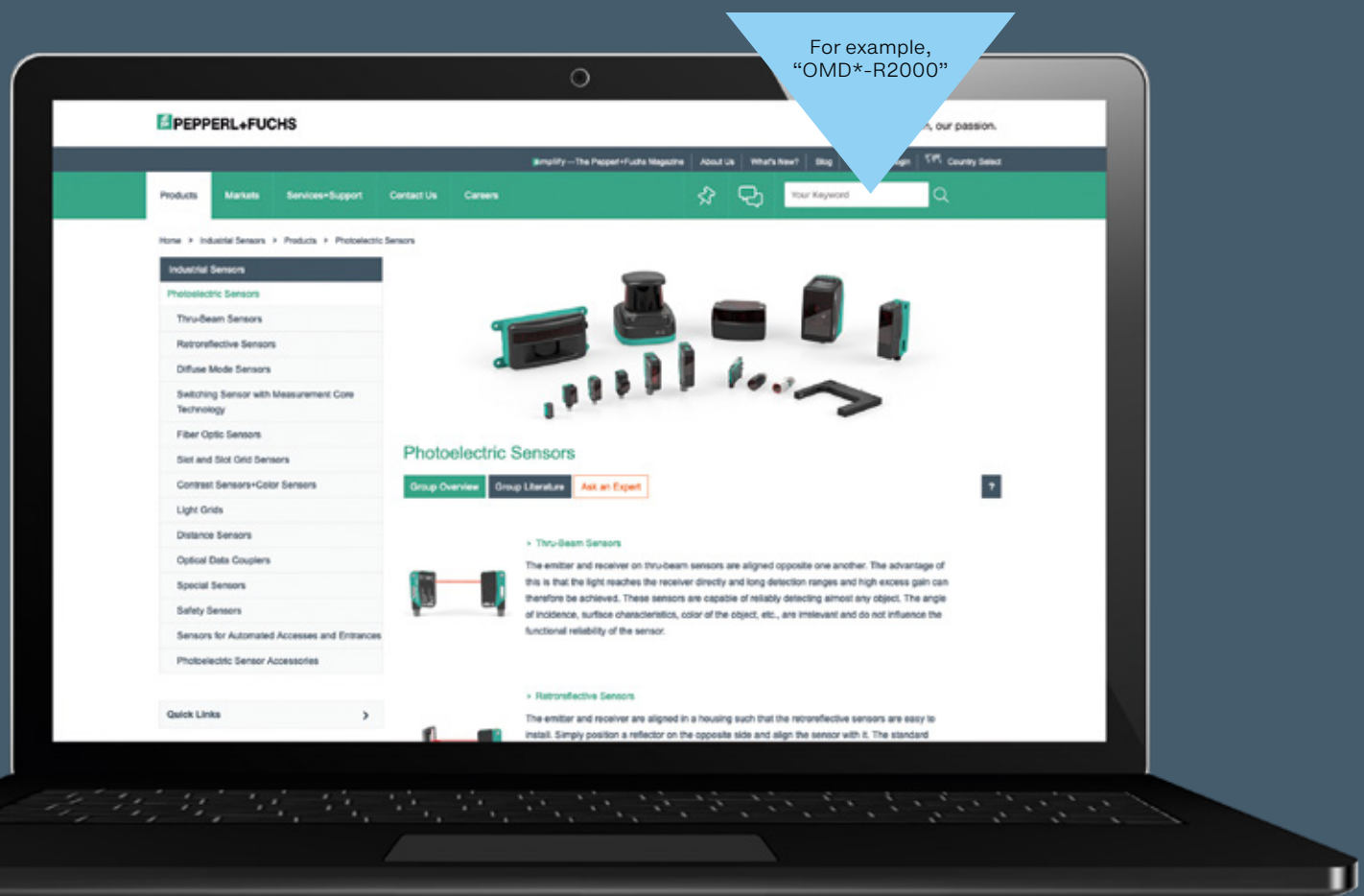

For more information, visit  
[pepperl-fuchs.com/pf-opto](http://pepperl-fuchs.com/pf-opto)

# Contents

<b>Photoelectric Sensors from Pepperl+Fuchs</b>	<b>6</b>
<b>Products</b>	<b>8</b>
<b>Standard Sensors</b>	<b>8</b>
Cubic Sensors	10
Cylindrical Sensors	21
Miniature Sensors	22
Slot and Slot Grid Sensors	24
Fiber Optic Sensors	25
Light Grids	26
<b>Measurement Technology</b>	<b>28</b>
2-D LiDAR Sensors	30
1-D Distance Sensors	34
<b>Optical Data Couplers</b>	<b>40</b>
<b>Safety Sensors</b>	<b>42</b>
<b>Accessories</b>	<b>44</b>
<b>Custom Sensors and Systems</b>	<b>46</b>



Pepperl+Fuchs

## Your Forward-Looking Partner

“Your automation, our passion”—our corporate claim is also our promise to you. We are dedicated to developing solutions and products that ideally solve your automation requirements and give you a significant competitive advantage. Looking back at everything Pepperl+Fuchs has achieved over the past 75 years since inventing the proximity sensor in 1954, it is clear that the company has always had a passion for innovation. The milestones we have reached are due to a core approach that has been the most important pillar of our success since the very beginning: working in partnership with you, our customers.

Whether we are selling industrial sensors or electrical explosion protection, we take the time to understand the unique needs and challenges of each customer. These requirements always provide the foundation for our activities today, and they will continue to do so in the future. This approach is especially important for the digital transformation of processes and applications in the automation industry in the context of Industry 4.0. We are driving progress in this field with the innovations and investments required to offer a comprehensive range of services that will pave the way for your IIoT-compatible applications. Reinterpreting proven technologies is just as important to us as developing state-of-the-art technical concepts, such as Ethernet-APL.

Our drive comes from always thinking one step ahead, realizing our visions for the industry, and continuing to shape the development of automation in the future.

Welcome to our world—prepare to be inspired!

[www.pepperl-fuchs.com](http://www.pepperl-fuchs.com)

## Sectors

# Photoelectric Sensors from Pepperl+Fuchs: a Portfolio Suitable for Every Scenario

**The requirements placed on industrial sensors are just as varied as the applications relevant to the automation industry. Pepperl+Fuchs has decades of experience and maintains the highest quality standards, making it the ideal partner for discerning customers in the fields of factory and process automation.**

The company offers a broad portfolio of standard photoelectric sensors and measurement technology. All of these products are precisely engineered for the demands of industrial automation. Various sensing modes, from conventional thru-beam sensors and diffuse mode sensors to high-performance distance sensors, are available in miniature, standard, and specialized designs. This forward-thinking portfolio concept guarantees maximum flexibility for users.

Aside from machine and plant construction and the automotive industry, photoelectric sensors are primarily used in material handling, mobile equipment, and the packaging and electronics industries. However, Pepperl+Fuchs also has exactly the right solution for each application in other fields.

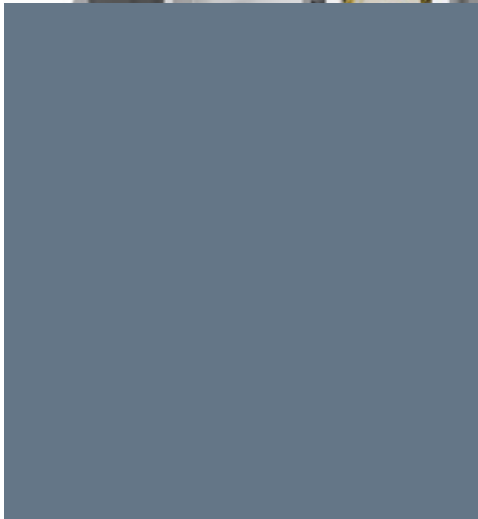
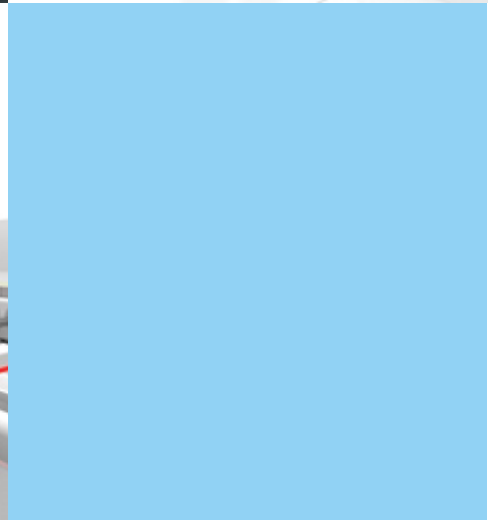
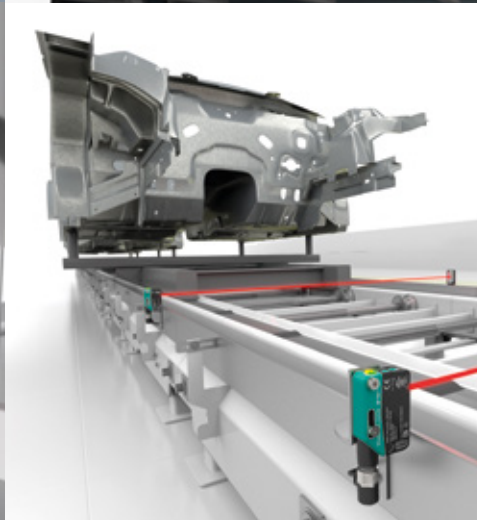
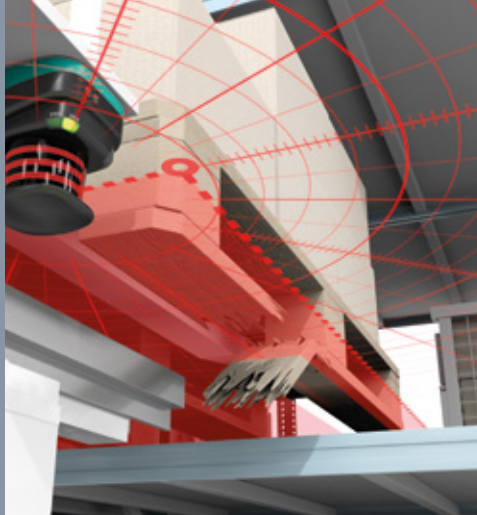
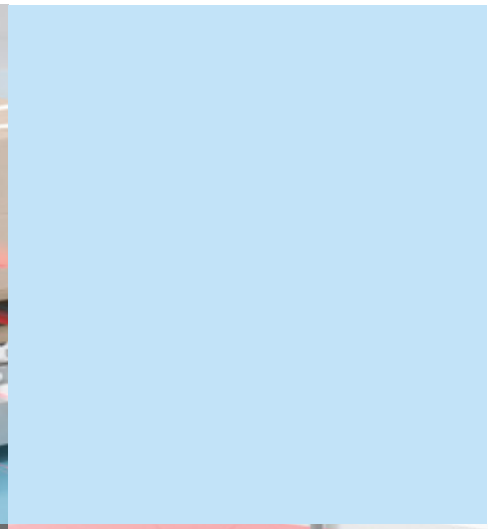
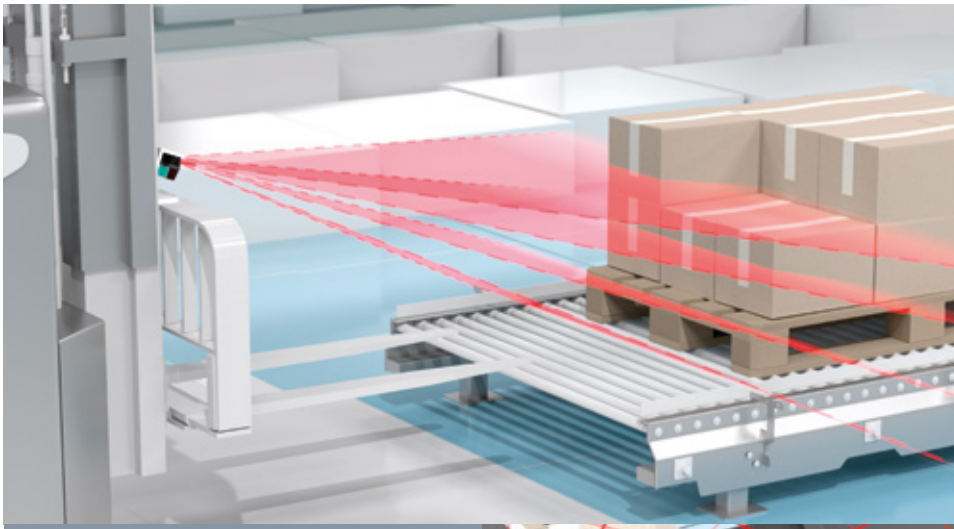

## Standard Sensors

# From Standard Designs to Highly Specialized Sensors

Pepperl+Fuchs integrates advanced photoelectric function principles into its standard designs. This concept for standard sensors is what delivers maximum flexibility for any application. Regardless of the installation scenario, the right sensor is always available as a thru-beam sensor, retroreflective sensor, diffuse mode sensor, or measuring sensor with multiple switch points.

In addition to standard designs, the extensive portfolio includes specialized devices such as fiber optic sensors, print mark contrast sensors, and slot and slot grid sensors. These devices have been carefully designed as optimal solutions for specific applications. They always adhere to the quality standards that customers have come to expect from Pepperl+Fuchs.



For more information, visit  
[pepperl-fuchs.com/pf-opto](https://www.pepperl-fuchs.com/pf-opto)







# The Ultimate Problem Solver

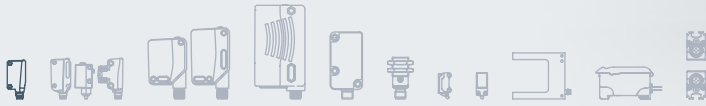

## Complex Capabilities in a Confined Space

The ML100 series from Pepperl+Fuchs is the solution for a wide range of highly demanding automation tasks. The sensors combine all sensing modes in an especially compact, cube-shaped housing. Holes with M3 threads enable quick and easy mounting. All devices feature a bright emitter LED and a clearly visible LED status indicator. Sensitivity adjusters and light-on/dark-on changeover offer excellent flexibility and optimal control of the sensing/detection range.

## PowerBeam Technology: For Maximum Performance

Offering the highest operating reserve on the market, PowerBeam technology helps to maintain completely stable and reliable operation. The clearly visible emitter LED makes it easy to align and adjust the sensor. Operating the product is equally convenient. The large, bright, and uniform light spot is especially useful for retroreflective sensors, including those with small reflectors.

Excerpt of technical data	M100/ MV100-RT	M100/ MV100- RT/35	M100/ MV100- 6090	M100/ MV100- 6091	M100/ MV100- 6757	ML100-5*	ML100-6	ML100- 55-G	ML100-8- 1000	ML100-8- W	ML100-8- HGU-100
<b>Function principle</b>	Thru-beam sensor					Retroreflective sensor with polarization filter	Retroreflective sensor without polarization filter	Retroreflective sensor for transparency detection	Energetic diffuse mode sensor		
<b>Red LED</b>	15 m	30 m	4 m	4 m	2 m	3 m, 4.5 m, 7 m		2.5 m	1,000 mm	200 mm	100 mm
<b>Infrared LED</b>	20 m						7 m				100 mm
<b>BlueBeam</b>											
<b>Specialized option</b>			Vertical optical face	Horizontal optical face	Vertical optical face					Large light spot	Long, narrow light spot

## BlueBeam Technology: For Demanding Tasks

BlueBeam technology works in a similar way to PowerBeam technology but features a blue LED beam with a wavelength of 470 nm; it has an equally powerful and uniform light spot. BlueBeam tackles some of the most difficult challenges in the electronics industry in the most effective way possible, such as detecting blue solar wafers and printed circuit boards.

## Highlights

- Wide range: from simple diffuse mode sensors and special sensors with three light spots to sensors with BlueBeam
- Extremely rugged due to the shock- and vibration-resistant housing
- Specialized design, suitable for cold-storage applications down to  $-30\text{ }^{\circ}\text{C}$

Excerpt of technical data	ML100-8-H	ML100-8-H-250	ML100-8-H-100/162	ML100-8-H-100	ML100-8-H
Function principle	Triangulation sensor with background suppression				Triangulation sensor with background evaluation
Red LED	350 mm	250 mm	100 mm	100 mm	350 mm
Infrared LED	200 mm				
BlueBeam	250 mm				
Specialized option			Three light spots	Small light spot	



For more information, visit  
[pepperl-fuchs.com/pf-ml100](https://www.pepperl-fuchs.com/pf-ml100)



# For Maximum Performance

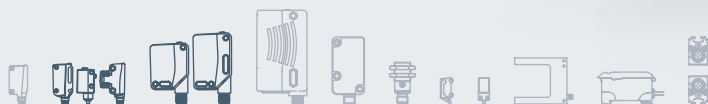

## Wide Range of Functions, Consistent Usability

The R10x and R20x series from Pepperl+Fuchs deliver powerful sensor technology based on all photoelectric sensing modes. The devices are available in five standard designs, each with the same sensing modes, standardized operation, and IO-Link. The future-oriented product architecture of the series enables simple integration along with maximum efficiency and planning reliability.

## Highlights

- IO-Link with Smart Sensor Profile in each sensor version for standardized communication down to sensor level (prerequisite for Sensorik4.0®)
- Precise and reliable MPT distance measurement, even in the smallest standard design
- Unique DuraBeam technology for optimal precision, maximum service life, and extended temperature ranges



For more information, visit  
[pepperl-fuchs.com/pf-r10xr20x](https://pepperl-fuchs.com/pf-r10xr20x)



## Simple and Intuitive Setup

The future-oriented product design of the R10x and R20x series impresses with its identical, well-organized, and simple user interface. Whether a retroreflective sensor, a diffuse mode sensor, or a measuring sensor is required, the sensing modes are always set up in the same way via the single combined user adjustment, regardless of the housing design and mounting. For maximum convenience, the series can be programmed via IO-Link and on the device itself.

## High-End Technology for Highly Reliable Measurement Results

DuraBeam technology is what gives the R10x and R20x series their superior performance. Multipixel technology (MPT) enables high-precision distance measurement at near range. These technologies are available in all five designs. Applications benefit from maximum efficiency, and reliable measurement results are obtained at all times.



# All Sensing Modes in a Small Housing Design

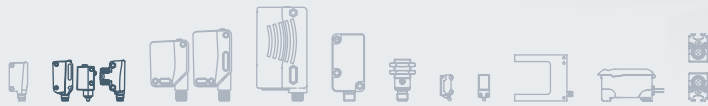

R101, R100, R103

## Highly Flexible and Extra Compact

The R10x sensor series from Pepperl+Fuchs offers maximum performance in a confined space. Three standardized designs benefit from all sensing modes. This series therefore includes the ideal sensor for every application's mounting and installation scenario. In addition to the PowerBeam LED and DuraBeam laser, the series includes specialized infrared versions for specific tasks.

Excerpt of technical data	OBE*-R100+; OBE*-R101*	OBR*-R100+; OBR*-R101*	OBR*-R100+; OBR*-R101*	OBG*-R100+; OBG*-R101*	OBD*-R100+; OBD*-R101*	OBT*-R100+; OBT*-R101*	OBT*-R100+; OBT*-R101*	OQT*-R100+; OQT*-R101*
<b>Function principle</b>	Thru-beam sensor	Retroreflective sensor with polarization filter	Retroreflective sensor without polarization filter	Retroreflective sensor for transparency detection	Energetic diffuse mode sensor	Triangulation sensor with background suppression	Triangulation sensor with background evaluation	Measuring sensor with multiple switch points
<b>LED detection/sensing range</b>	12 m, 20 m (IR)	7.5 m	7 m (IR), 10 m (IR)	5 m	1,000 mm, 1,100 mm (IR)	150 mm, 150 mm (IR), 350 mm, 350 mm (IR)		150 mm, 150 mm (IR)
<b>DuraBeam laser detection/sensing range</b>	20 m	12 m				100 mm, 300 mm		150 mm



For more information, visit  
[pepperl-fuchs.com/pf-r10xr20x](https://pepperl-fuchs.com/pf-r10xr20x)

Excerpt of technical data	OBE*-R103*	OBR*-R103*	OBG*-R103*	OBD*-R103*	OBT*-R103*	OBT*-R103*	OQT*-R103*
<b>Function principle</b>	Thru-beam sensor	Retroreflective sensor with polarization filter	Retroreflective sensor for transparency detection	Energetic diffuse mode sensor	Triangulation sensor with background suppression	Triangulation sensor with background evaluation	Measuring sensor with multiple switch points
<b>LED detection/sensing range</b>	10 m	6 m	4 m	800 mm	300 mm		120 mm
<b>DuraBeam laser detection/sensing range</b>	20 m	12 m			80 mm, 250 mm		120 mm

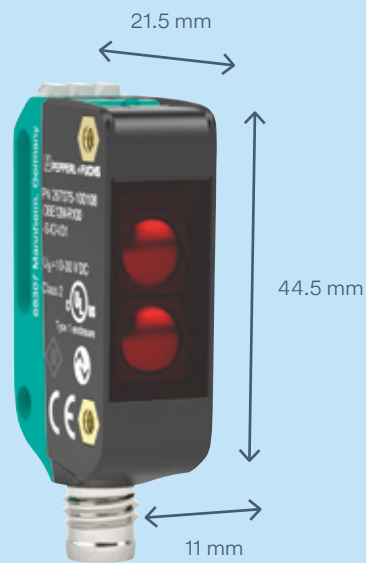

# All Sensing Modes in a Medium-Sized Housing Design



R200, R201

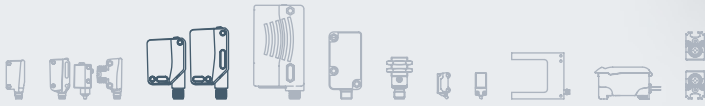

## Wide Variety of Applications in a Space-Saving Housing

Like the smaller, related R10x series, the medium-sized R200 and R201 series offer all sensing modes, standardized operation, powerful sensor technology, and IO-Link in every design. In addition, a swivel plug and extended sensing and detection ranges offer greater flexibility and facilitate a wider range of applications.



For more information, visit  
[pepperl-fuchs.com/pf-r10xr20x](https://pepperl-fuchs.com/pf-r10xr20x)



Excerpt of technical data	OBE*-R200*, OBE*-R201*	OBR*-R200*, OBR*-R201*	OBG*-R200*, OBG*-R201*	OBD*-R200*, OBD*-R201*	OBT*-R200*, OBT*-R201*	OBT*-R200*, OBT*-R201*	OQT*-R200*, OQT*-R201*
<b>Function principle</b>	Thru-beam sensor	Retroreflective sensor with polarization filter	Retroreflective sensor for transparency detection	Energetic diffuse mode sensor	Triangulation sensor with background suppression	Triangulation sensor with background evaluation	Measuring sensor with multiple switch points
<b>Red LED</b>	25 m	15 m	8 m	1,400 mm	300 mm, 650 mm		400 mm
<b>DuraBeam laser</b>	40 m	25 m			600 mm		350 mm



# Wide Range of Applications, Cost-Effective Design



## All Sensing Modes Available

The R202 series was optimized specifically for the broad market of standard automation. The standard design works with a variety of mounting options. All sensing modes are available, from the thru-beam sensor and retroreflective sensor to diffuse mode sensors. Every version operates with a wide voltage range from 24 V AC/DC to 240 V AC/DC. The integrated solid-metal threaded bushings maintain a secure and stable mounting.

## Highlights

- Optimized, highly cost-effective design
- All sensing modes are available
- Specialized version for detecting foil-wrapped objects
- Wide-range power supply for AC and DC versions

Excerpt of technical data	OBE35M-R202*	OBR17M-R202*	OBD2000-R202*	OBT1250-R202*
<b>Dimensions (W × H × D)</b>	20 mm × 61.9 mm × 41.7 mm			
<b>Operating voltage</b>	10 V DC ... 30 V DC or 24 V AC/DC ... 240 V AC/DC			
<b>Measuring range</b>	0 m ... 35 m	0.05 m ... 17 m	2 mm ... 2,000 mm	20 mm ... 1,250 mm
<b>Specialized option</b>		Detection of foil-wrapped objects		

# An Impressive Design When Standard Sensors Reach Their Limits

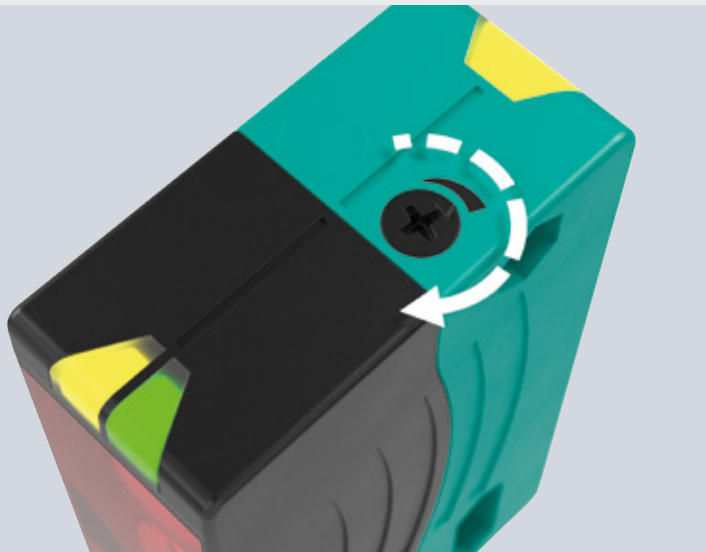
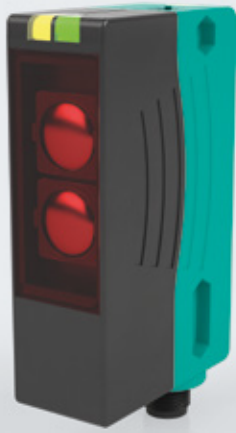

## Maximum Precision and Optimal Ease of Use

The R300 series from Pepperl+Fuchs offers sensors for simple to highly complex switching tasks. Where conventional sensors or retroreflective sensors reach their limits, the R300 can utilize the enormous advantages of Pulse Ranging Technology (PRT). Internal distance measurement ensures fully reliable background suppression. The R300 series encompasses this high-end technology within its highly cost-effective designs. A large light spot and simple adjustment options, such as the quick-twist function, guarantee optimal ease of use.

## Highlights

- Highly cost-effective
- Significantly larger detection ranges than standard sensors of the same design
- Quick switch-point adjustment via the teach-in button
- Sensing range adjuster provided via the quick-twist function
- Large light spot ensures reliable object detection and easy adjustment
- Fully reliable background suppression

Excerpt of technical data	OMD-8000*L	OMR-50M*
<b>Dimensions (W × H × D)</b>	25.8 mm × 88 mm × 54.3 mm	
<b>Adjustment range</b>	0.05 m ... 8 m	0.2 m ... 50 m (on reflector)
<b>Diameter of the light spot</b>	Vertical 60 mm, horizontal 30 mm at a distance of 2 m	Approx. 16 cm × 18 cm at a distance of 10 m
<b>Interface</b>	Two push-pull outputs	
<b>Light emitter</b>	Laser, class 1M	Red LED



For more information, visit  
[pepperl-fuchs.com/pf-r300](https://pepperl-fuchs.com/pf-r300)

# The Extra-Slim Cost Saver

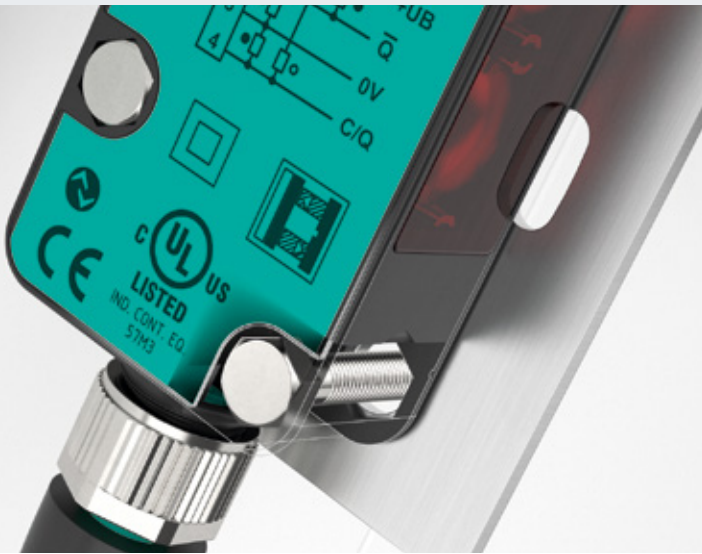

Socket for internal hexagon head screws

## Simple User Interface, Exceptional Performance Data

The RL31 series of diffuse mode sensors is the ideal solution for standard object-detection tasks. The highly compact design of these universal voltage and extra-low-voltage devices offers maximum flexibility when mounting in confined spaces. Despite the very low housing depth, the sensors deliver excellent optical performance data and guarantee safe, reliable operation at all times. The devices impress with their exceptionally large scanning range of up to 800 mm and a consistently small bw/wb difference.

## Highlights

- Diffuse mode sensor with four adjustable sensing modes
- Exceptionally large, adjustable scanning range of up to 800 mm
- Dual push-pull output
- Simple, user-friendly adjustment
- Very flexible mounting options with recessed hexagon sockets
- Comprehensive range of mounting accessories available
- High-visibility LED status indicator
- Extra-compact AC devices

Excerpt of technical data	LD31/LV31*	LA31/LK31*	RL31*	RLK31*	RLK31*	RL31*	RLK31*	RL31*
<b>Function principle</b>	Thru-beam sensor		Retroreflective sensor with polarization filter		Retroreflective sensor without polarization filter	Energetic diffuse mode sensor		Triangulation sensor with background suppression
<b>Operating voltage</b>	30 V DC	240 V AC/DC	30 V DC	240 V AC/DC	240 V AC/DC	30 V DC	240 V AC/DC	30 V DC
<b>Red LED</b>	30 m		12 m		16.5 m	1,200 mm		800 mm
<b>Infrared LED</b>						2,500 mm		
<b>IO-Link</b>								Optional



For more information, visit  
[pepperl-fuchs.com/pf-rl31](http://pepperl-fuchs.com/pf-rl31)

# Functionality and Efficiency in a Cylindrical Design

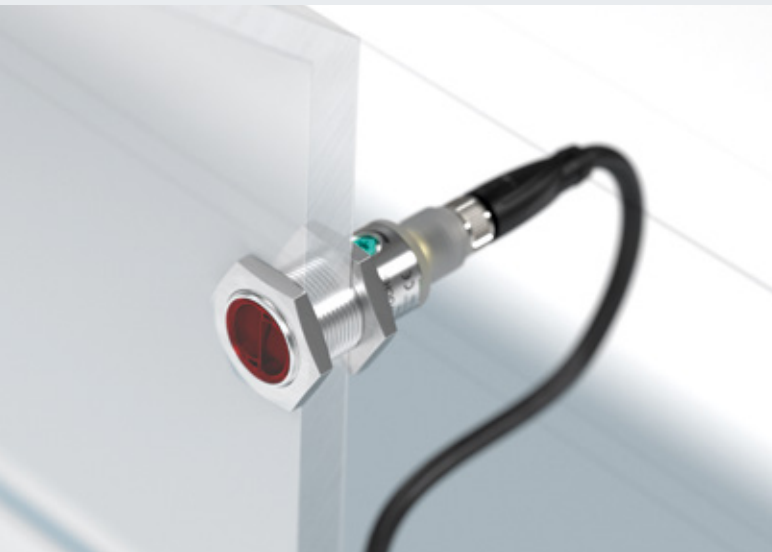
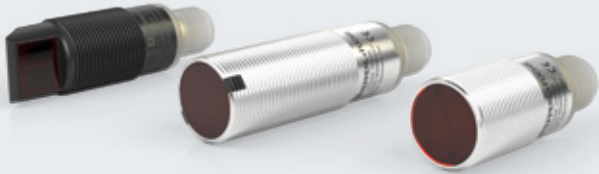

## Broad Portfolio for Custom Solutions

The M18 series is highly functional and very flexible. This extensive cylindrical portfolio comprises five sensing modes within three different designs. This makes it easy to choose the ideal product according to the housing design or the specific mounting scenario. All devices are based on a standardized, tried-and-tested operating concept. They have been designed as the optimal solution for standard applications.

## Highlights

- Side-looker version can be installed from below and provides views around corners
- Shortened housing design of only 40 mm requires less installation space
- For use in material-handling applications: metal housing and metal thread guarantee high mechanical stability

Excerpt of technical data	OBE*18G*	OBG*18G*	OBG*18G*	OBD*18G*	OBT*18G*
<b>Function principle</b>	Thru-beam sensor	Retroreflective sensor with polarization filter	Retroreflective sensor for transparency detection	Energetic diffuse mode sensor	Triangulation sensor with background suppression
<b>Housing</b>	40 mm plastic; 40 mm metal; 60 mm metal				
<b>Front-looker Red LED</b>	25 m	5.5 m	3.5 m	600 mm	150 mm, 300 mm
<b>Side-looker Red LED</b>	15 m	5 m	3 m	450 mm	



For more information, visit [pepperl-fuchs.com/pf-m18](https://www.pepperl-fuchs.com/pf-m18)

# Extra-Rugged, Slim Housing

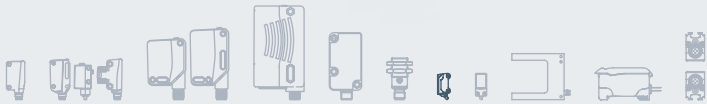

## Abrasion-Resistant Plastic Front for Demanding Ambient Conditions

R2/R3 series devices are the perfect choice where sensors must be mounted in close proximity to a moving object due to space limitations. The miniature housings with a rugged plastic front are ideal for applications in confined spaces and in difficult ambient conditions. The design guarantees fault-free and reliable plant operation at all times.

## Highlights

- Ruggedness and flexibility, optimally combined in a highly compact housing
- Miniature housing for confined installation scenarios
- Reliable use even for dusty applications
- Can be mounted directly on the moving object



### Excerpt of technical data

	OBE*R2, OBE*R3	OBR*R2, OBR*R3	OBT*R2, OBT*R3
<b>Function principle</b>	Thru-beam sensor	Retroreflective sensor with polarization filter	Triangulation sensor with background suppression
<b>Red LED</b>	2 m	1 m	15 mm, 30 mm, 50 mm, 80 mm
<b>DuraBeam laser</b>	10 m	2 m	15 mm, 30 mm, 50 mm, 80 mm



For more information, visit [pepperl-fuchs.com/pf-r2r3](https://www.pepperl-fuchs.com/pf-r2r3)

# Multiple Benefits in a Winning Design

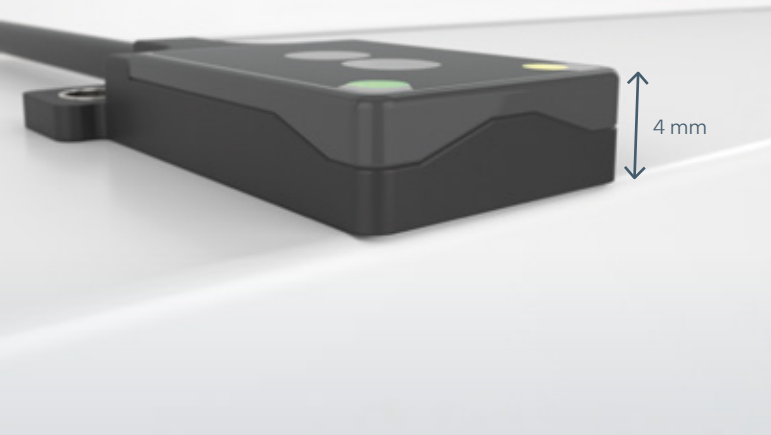
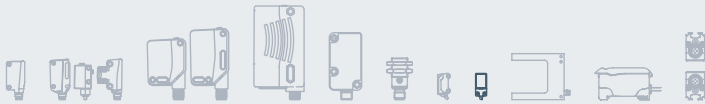
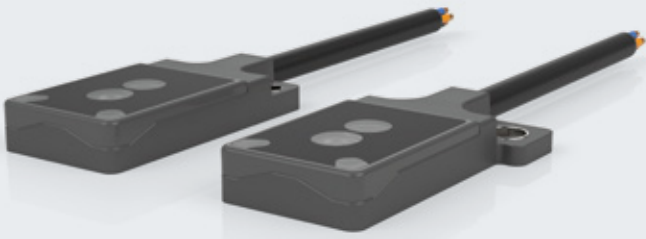

## Maximum Performance from the Flattest Housing Option

The R2F/R3F series is Pepperl+Fuchs' extra-flat design in its photoelectric sensors portfolio. The front-mounted devices are available with either M2 or M3 mounting holes. Despite its exceptionally flat design, this sensor series offers all sensing modes: thru-beam sensors, retroreflective sensors, and triangulation sensors with background suppression. Innovative DuraBeam laser technology provides maximum precision for detecting small parts. The R2F/R3F series offers all this in the tightest of spaces with the flattest laser sensor in the world.

## Highlights

- Multipurpose high-performance sensors
- Equipped with DuraBeam—the flattest laser sensors in the world
- Available as a thru-beam sensor, retroreflective sensor, or triangulation sensor with background suppression

### Excerpt of technical data

	OBE*R2F; OBE*R3F	OBR*R2F; OBR*R3F	OBT*R2F; OBT*R3F
<b>Function principle</b>	Thru-beam sensor	Retroreflective sensor with polarization filter	Triangulation sensor with background suppression
<b>Red LED</b>	500 mm		15 mm, 30 mm
<b>DuraBeam laser</b>	500 mm, 1,500 mm	1,500 mm	15 mm, 30 mm



For more information, visit [pepperl-fuchs.com/pf-r2r3](https://pepperl-fuchs.com/pf-r2r3)

# The Specialists for Short Distances

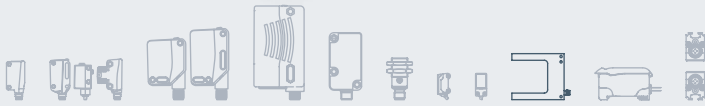

## Wide Selection, Easy Mounting

The broad portfolio of photoelectric sensors from Pepperl+Fuchs includes specialized versions, such as photoelectric slot sensors, in a wide variety of sizes. Slot sensors are used when only small distances need to be bridged between the emitter and receiver. The main advantage is that only one device needs to be connected and the adjustment of the optical axes at the factory makes mounting much easier. Offering high switch-point accuracy, these sensors are the perfect choice for precise positioning tasks, such as presence monitoring on feed devices, ejection control of small parts, counting of bulk material on vibration conveyors, and small-part detection.

## Highlights

- Miniature designs for detection of small parts down to 0.8 mm
- Slot widths up to max. 220 mm
- Rugged metal versions are available
- Degree of protection up to IP67

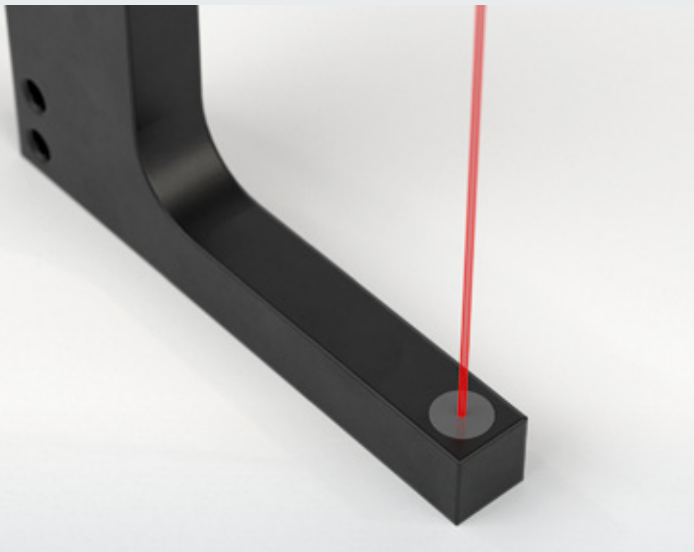

### Excerpt of technical data

	GL10*; GL20*; GL30*; ...	GL30*; GL50*; GL80*; ...
Slot width	10 mm, 20 mm, 30 mm, 40 mm, 50 mm, 80 mm, 121 mm, 220 mm	30 mm, 50 mm, 80 mm, 121 mm
Housing	Metal	Plastic
Red LED	■	■
Infrared LED	■	



For more information, visit  
[pepperl-fuchs.com/pf-gl](https://www.pepperl-fuchs.com/pf-gl)



# The Rugged High-Power Solutions

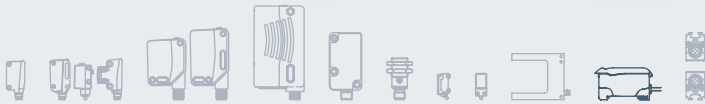

## Simple Installation, Convenient Handling

The SU19 series from Pepperl+Fuchs is a range of exceptionally high-performance fiber optic sensors. These sensors can detect objects in especially harsh ambient conditions, such as high temperatures, mechanical vibrations, and in contact with highly corrosive cleaning agents. The slim design of the sensors enables optimal object detection even in very confined mounting conditions. Depending on the application requirements, up to 18 fiber optic sensors can be mounted in rows without the devices influencing each other. The especially user-friendly sensor concept consisting of primary and secondary modules allows the devices to be connected easily via rear bridge contacts.

## Highlights

- Four-digit, high-resolution percentage display
- Suitable for plastic and glass fiber optic
- AGC for a convenient, time-saving teach-in process
- Quick and easy setup via push button or potentiometer
- Extra-slim designs are available for DIN rail mounting
- Degree of protection up to IP67

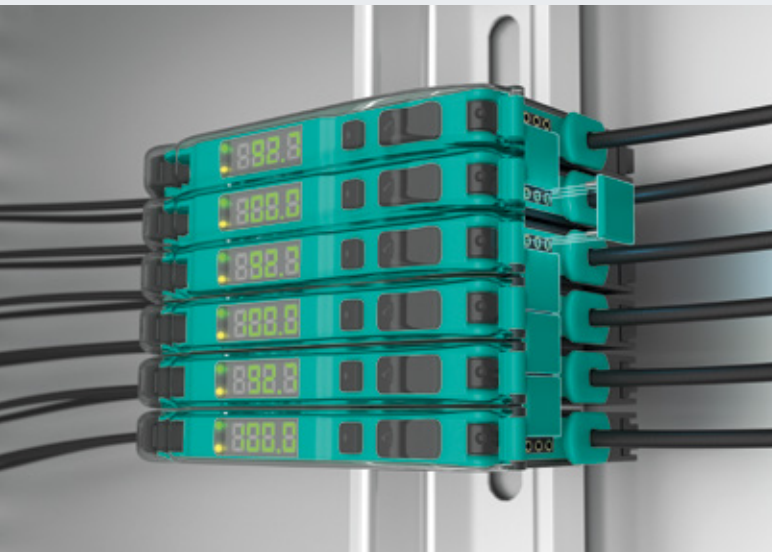

Devices connected via rear bridge contacts

Excerpt of technical data	SU19* (primary module)	SU19.1* (secondary module)	SU18/16/35*	SU18/35*	SU18/16*	SU18*
Four-digit display	■	■				
High power			■	■		
Potentiometer			■		■	
Teach-in	■	■		■		■
AGC	■	■	■	■	■	■



For more information, visit  
[pepperl-fuchs.com/pf-su](http://pepperl-fuchs.com/pf-su)

# Ultraquick and Extra Smart

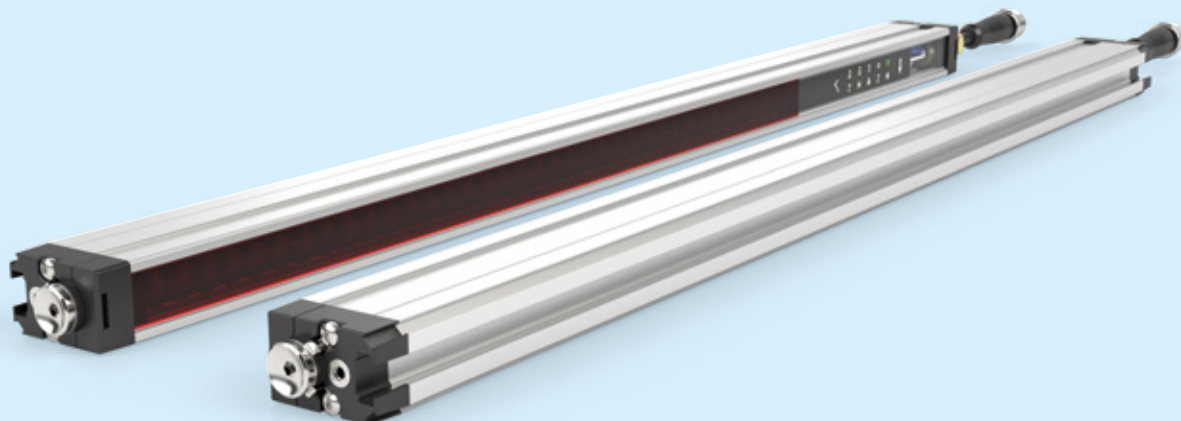

## Easy Integration for a Wide Range of Applications

The LGS and LGM series of light grids impress with many integrated measuring functions and extremely quick object detection, even with three-way crossover. An integrated IO-Link interface enables intelligent programming and comprehensive diagnosis from the control level. The convenient user interface makes it especially easy to mount and set up these devices. In addition to standard applications, such as object detection and overhang monitoring, the LGS series offers superior extra functions, such as sag monitoring. And with object height measurement, volume measurement, and object identification capabilities, the LGM series guarantees maximum versatility.

Excerpt of technical data	LGS*	LGM*
<b>Effective detection range</b>	0.3 m ... 6 m (standard) 0.5 m ... 8 m (option/35)	0.3 m ... 6 m
<b>Beam spacing</b>	8 mm, 17 mm, 25 mm, 50 mm, 100 mm	8 mm, 17 mm, 25 mm, 50 mm
<b>Beam crossover</b>	Three-way (can be disabled)	
<b>Field height</b>	Min. 100 mm, max. 3,200 mm (in 100 mm increments)	
<b>Optical resolution</b>	Without crossover: 8 mm; with crossover: 4 mm	
<b>Switching type</b>	Light-on/dark-on switching, adjustable	
<b>Temperature range</b>	-10 °C ... +60 °C (standard) -30 °C ... +60 °C (option /146)	-30 °C ... +60 °C



For more information, visit  
[pepperl-fuchs.com/pf-lg](https://www.pepperl-fuchs.com/pf-lg)

## Highlights

### LGS Light Grid

- Simple, software-free parameterization via touchpad or external input
- Extremely quick object detection—even with three-way crossover

### LGM Measuring Light Grid

- User-friendly setup with 16 measuring functions available
- Highly convenient integration by direct measured value output in millimeters—without complex single-beam evaluation
- Extra-rugged housing design guarantees protection up to IP67

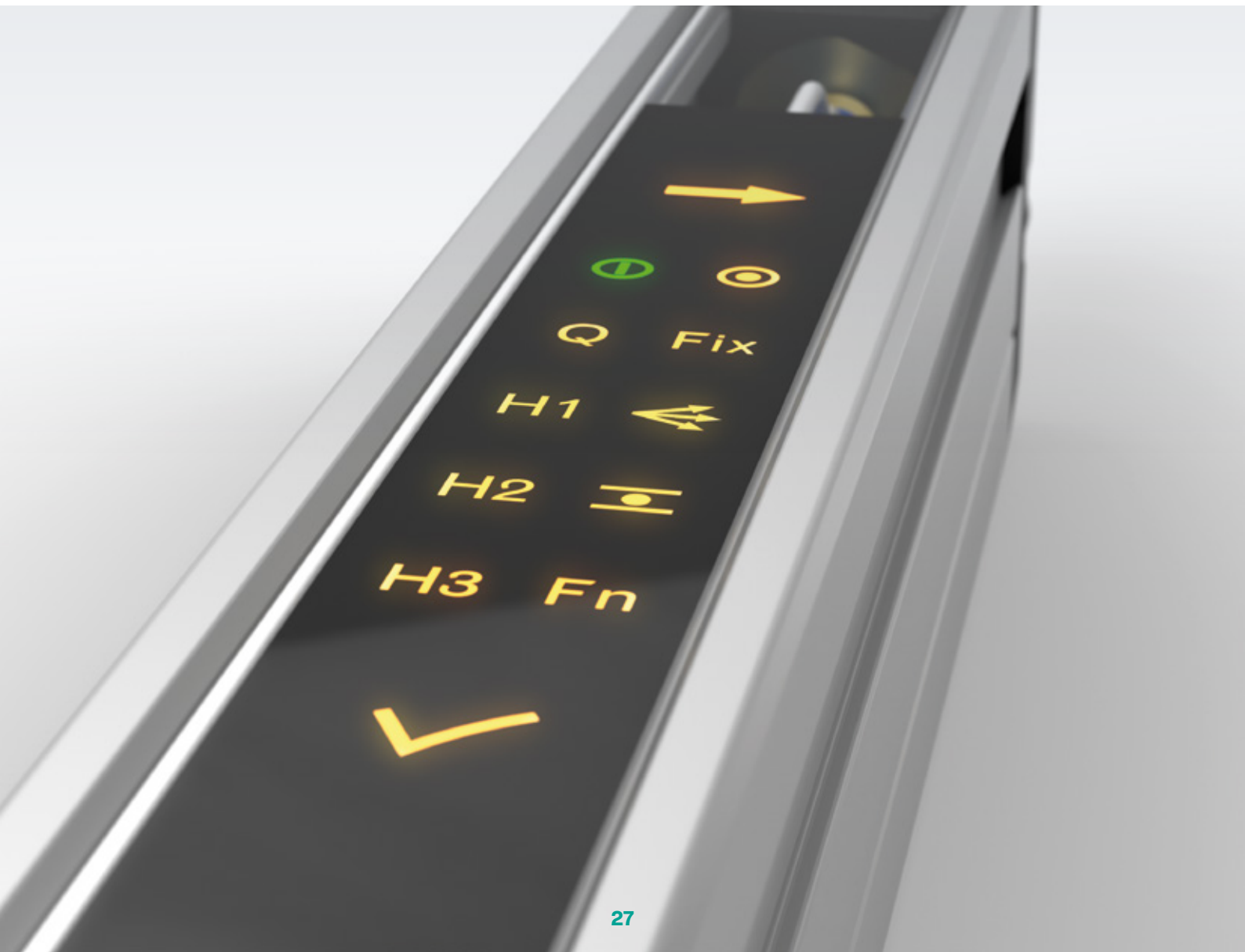

Measurement Technology

# From Basic Requirements to High-End Applications

With decades of experience and extensive technical expertise, Pepperl+Fuchs is constantly expanding its extensive portfolio of in-house measurement technology. A large number of powerful technologies are already available: multipixel technology (MPT) for highly precise, small devices, Pulse Ranging Technology (PRT) for large measuring ranges from 1-D to 3-D, and optical data transfer as a communication solution for industrial Ethernet.

The company systematically drives the development of these technologies and innovative ideas. One example is LiDAR sensors with Pulse Ranging Technology (PRT) for high-precision and reliable measurement results. This approach ensures that new and increasingly powerful sensor solutions, suitable for every application, will be available in the future.



For more information, visit  
[pepperl-fuchs.com/pf-distance](https://www.pepperl-fuchs.com/pf-distance)

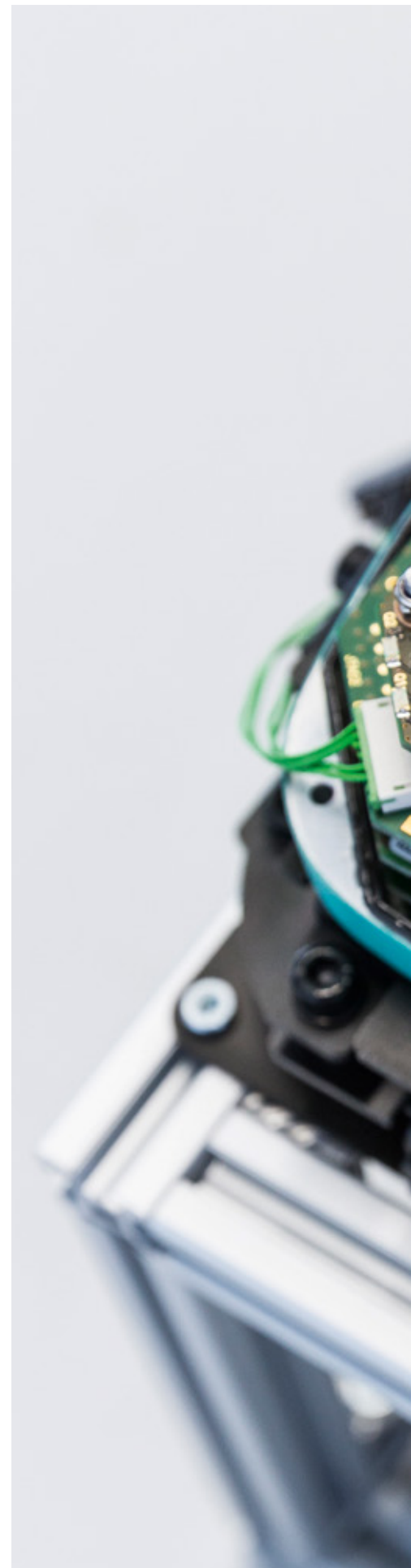

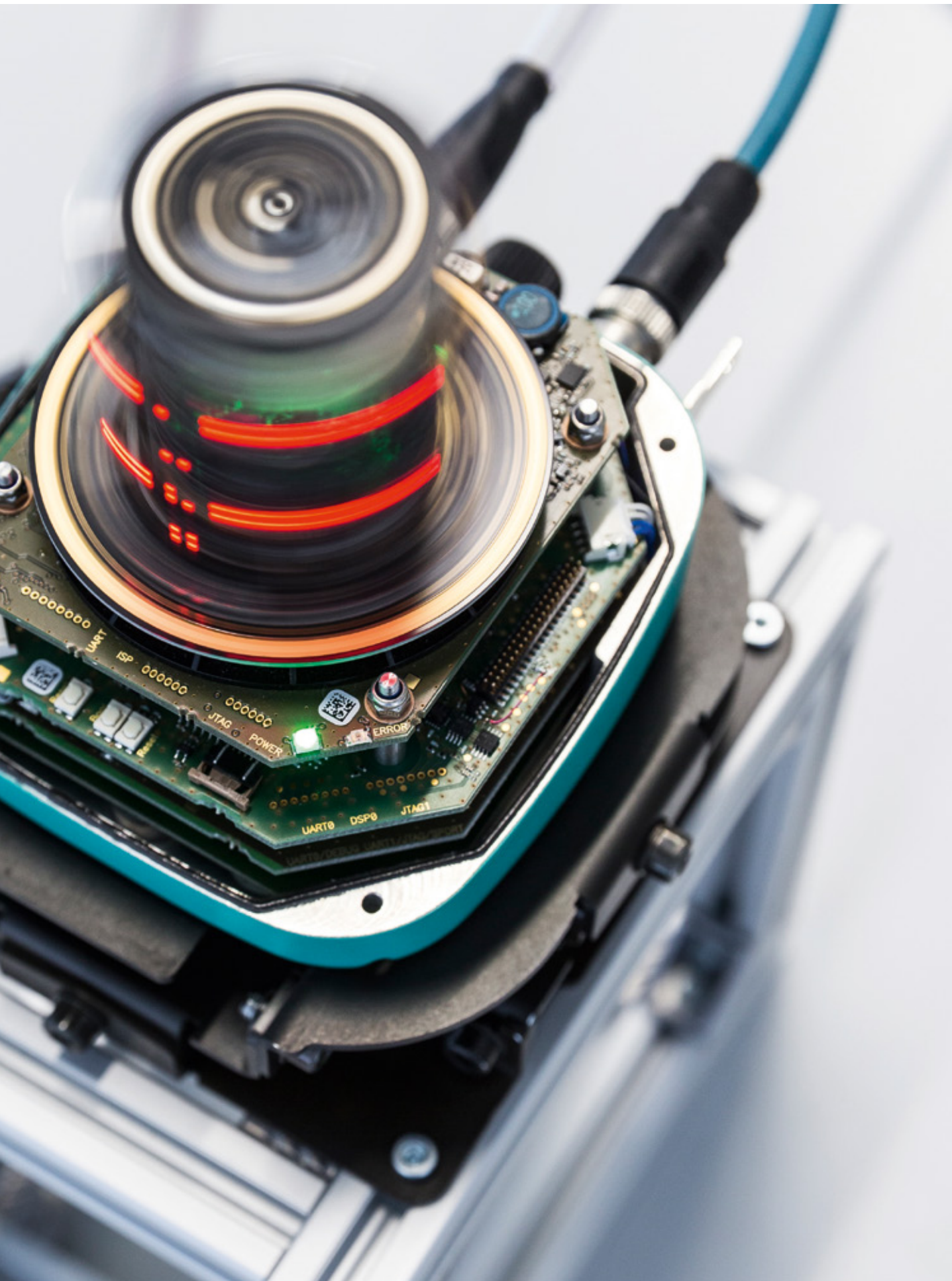

# Maximum Precision Down to the Smallest Detail

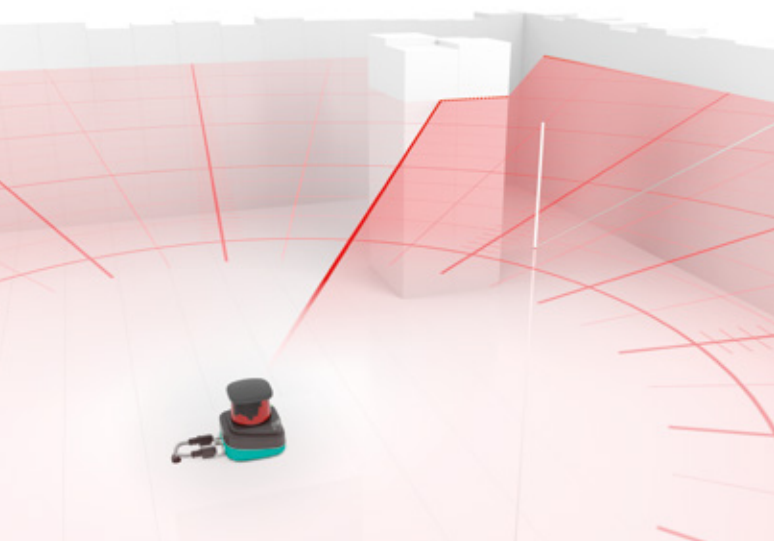

Detection of the smallest objects and precise edge detection

## 360° Measuring Angle for All-Around Visibility

The R2000 series offers a unique combination of features. The 2-D laser scanners deliver clear, highly accurate measurement results. This means that a small light spot combined with high angular resolution enables the detection of even the smallest objects down to one millimeter in size. Absolutely reliable object detection and clear measurement results are achievable even in the most difficult ambient conditions, and the 360° measuring angle guarantees all-around visibility at all times.

## Highlights

- Highly precise measurement data output
- All-around visibility with the 360° measuring angle
- Small light spot for detecting even the smallest objects and precise edge detection
- Extra-compact design for this performance class facilitates mechanical integration
- Interactive wrap-around display for easy programming and output of valuable diagnostic information

Excerpt of technical data	OMD*-R2000-B23-V1V1D* (Ultra High Density)	OMD*-R2000-B23-V1V1D-HD* (High Density)
<b>Measuring range</b>	10 m to object/60 m to reflector 30 m to object/200 m to reflector 60 m to object/200 m to reflector	30 m to object/30 m to reflector
<b>Scanning angle</b>	360°	
<b>Repeatability</b>	< 12 mm	
<b>Angular resolution</b>	≥ 0.014°	≥ 0.043°
<b>Measuring rate</b>	Up to 250,000 measurements/s	Up to 84,000 measurements/s



For more information, visit  
[pepperl-fuchs.com/pf-r2000lp](http://pepperl-fuchs.com/pf-r2000lp)

# A Multitalented Device with All-Around Visibility



## Reliable Performance for the Most Demanding Monitoring Tasks

R2000 Detection series sensors are designed for detecting the smallest objects in dynamic applications. The devices impress with their simple user interface, a highly stable scanning layer, and the best angular resolution among discrete output scanners. This combination of features makes the scanners ideal for tasks such as gap control and empty storage bay detection. The devices have four freely definable fields of view and are available as infrared-light (OBD30M) or red-light versions (OBD10M) on request. These devices can monitor a measuring range of up to 30 meters on natural objects with maximum reliability.

## Highlights

- Discrete output sensor for field monitoring
- Exceptionally accurate surface monitoring via an extra-flat scanning layer
- Best angular resolution among discrete output scanners (up to 0.071°) enables detection of even the smallest objects
- Four freely definable fields of view for easy handling
- Infrared-light and red-light versions available

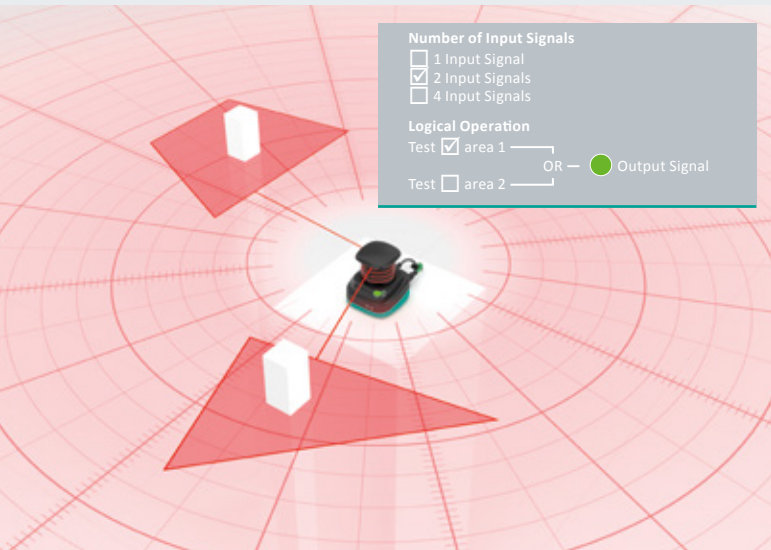

Logic function for logical linking of field states and inputs

### Excerpt of technical data

### OBD\*-R2000\*

<b>Measuring range</b>	10 m to object/30 m to reflector 30 m to object/30 m to reflector
<b>Scanning angle</b>	360°
<b>Repeatability</b>	< 12 mm
<b>Angular resolution</b>	≥ 0.071°
<b>Number of switch fields</b>	Four freely programmable fields



For more information, visit  
[pepperl-fuchs.com/pf-r2000lp](http://pepperl-fuchs.com/pf-r2000lp)

# Perfect Monitoring at Every Level

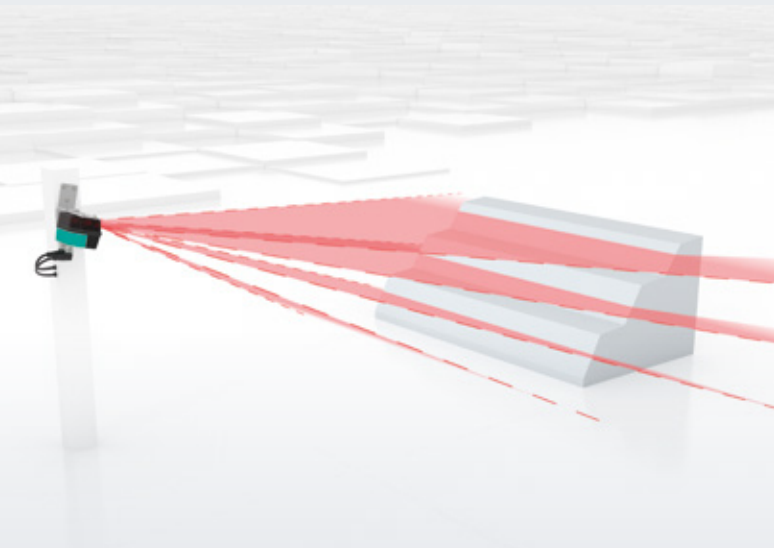

### High-Precision Measurements in a Rugged Design

The R2300 multilayer scanner provides significantly more scanning information than conventional single-layer devices. Users obtain a much more reliable detection result from the sensing range. Featuring Pulse Ranging Technology (PRT), the sensor delivers these highly precise and reliable measurements largely independently of ambient and object conditions. The fact that only one multilayer scanner is required instead of several single-layer devices significantly reduces acquisition, wiring, and integration costs.

### Highlights

- Multilayer scanner for maximum reliability and cost efficiency in the case of 3-D measurements
- Very high angular resolution and small light spot for this device class
- Ideal for navigation, positioning, and detection applications
- Switchable, visible pilot laser enables precise orientation and easy commissioning
- Electronics without moving parts significantly increase ruggedness, efficiency, and durability

#### Excerpt of technical data

#### OMD\*-R2300\*

<b>Measuring range</b>	10 m on white (90 %) 4 m on black (10 %)
<b>Scanning angle</b>	100°
<b>Repeatability</b>	12 mm
<b>Angular resolution</b>	0.1°
<b>Light type</b>	Measuring laser: infrared (laser class 1) Alignment laser: red (laser class 1)



For more information, visit  
[pepperl-fuchs.com/pf-r2300](https://www.pepperl-fuchs.com/pf-r2300)



# Focusing on the Most Important Detail at All Times

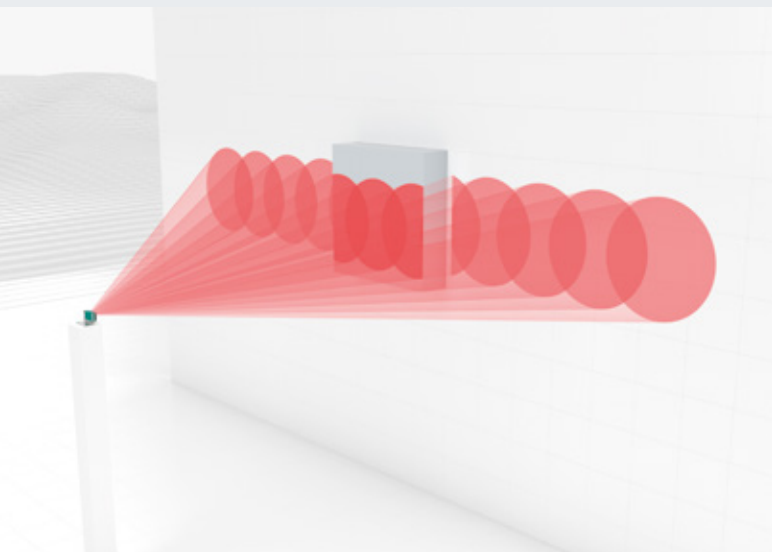
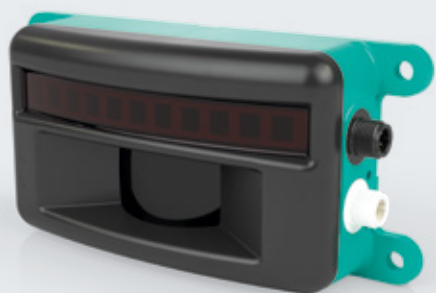

### Innovative Technology, Highly Precise Measurements

The R2100 series of two-dimensional multiray LED scanners offers the perfect combination of Pulse Ranging Technology (PRT) and multichannel measurement. The multiple LED emitters of the devices are arranged side by side and enable two-dimensional monitoring via 11 individual measurements. This means that the devices deliver completely reliable and highly stable measurement data at all times, regardless of the ambient conditions. These features make the R2100 ideal for applications in the fields of mobile equipment, intralogistics, and machine and plant construction.

### Highlights

- No moving parts: ideal for mechanically demanding applications
- Long service life due to measurement using LEDs
- 2-D measurement via 11 individual beams
- Eye-safe technology due to LEDs
- Large light spot: perfect for different surface structures

#### Excerpt of technical data

#### OMD\*-R2100\*

<b>Dimensions (L × W × H)</b>	157 mm × 81 mm × 45 mm
<b>Measuring range</b>	0.2 m ... 2 m on black (6 %) 0.2 m ... 8 m on white (90 %)
<b>Scanning angle</b>	88°
<b>Measurement noise</b>	20 mm (1 sigma)
<b>Angular resolution</b>	8°



For more information, visit  
[pepperl-fuchs.com/pf-r2100](https://www.pepperl-fuchs.com/pf-r2100)

1-D Distance Sensors—R1000 Series

# A Compact Design with Exceptional Precision

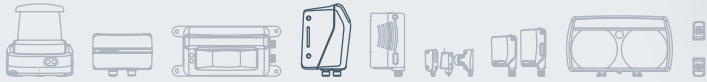

## Intelligent Technology, Quick Commissioning

The R1000 series of distance sensors from Pepperl+Fuchs impresses with highly intelligent Pulse Ranging Technology (PRT) and absolutely precise data up to a distance of 300 meters. The sensors are ideal for distance measurement and positioning tasks in dynamic applications where an extremely high measuring rate is required—such as in the case of automated storage and retrieval systems used in material handling. Featuring integrated metal threaded holes, the sensors can be mounted directly, quickly, and conveniently using M6 screws and no other accessories.

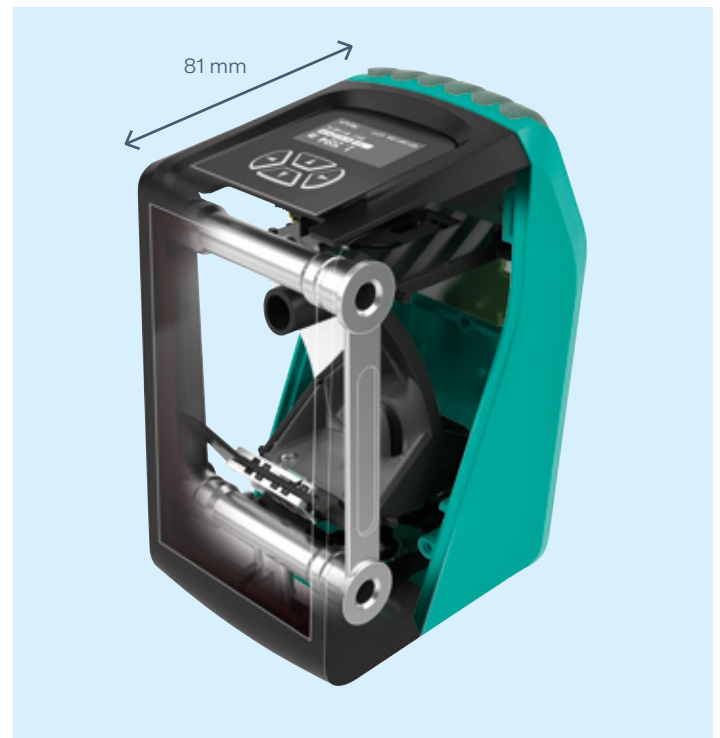

For more information, visit  
[pepperl-fuchs.com/pf-r1000](https://www.pepperl-fuchs.com/pf-r1000)

## Highlights

- Rugged, highly compact housing for optimal integration in confined installation situations
- Integrated metal threaded holes enable easy, direct mounting for short measuring distances
- Optional adjustment device for large detection ranges
- Pulse Ranging Technology (PRT) for high-precision distance measurement up to 300 meters
- Resistant to environmental influences such as ambient light, dirt, and dust

### Excerpt of technical data

### OMR\*-R1000\*

<b>Dimensions (W × H × D)</b>	55 mm × 107 mm × 81 mm
<b>Measuring range</b>	0.3 m ... 50 m, 0.3 m ... 150 m
<b>Operating voltage</b>	10 ... 30 VDC
<b>Repeat accuracy</b>	< 1 mm
<b>Interface</b>	SSI, RS-422
<b>Laser class</b>	1

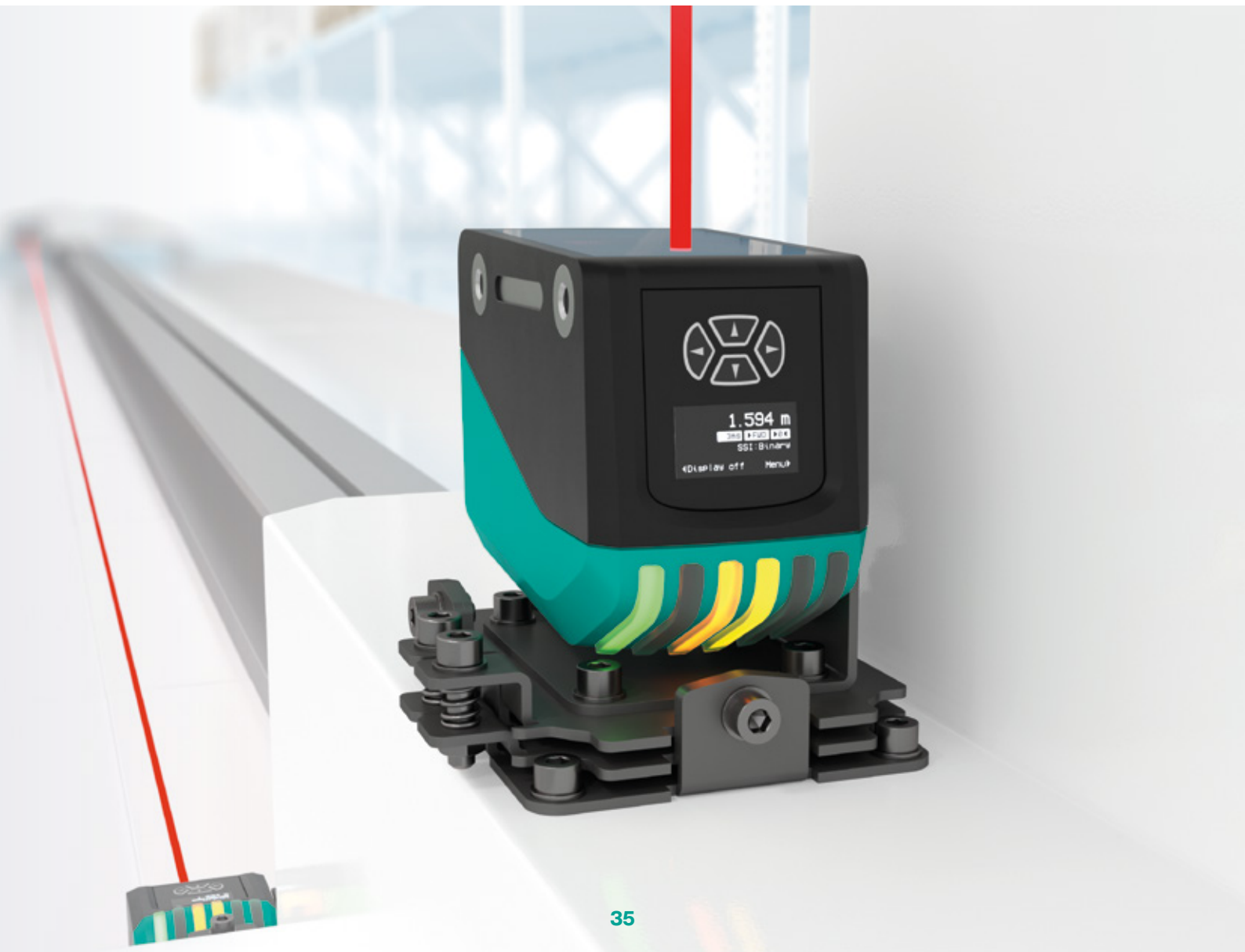

# Maximum Precision for Interference-Resistant Tasks



## Exceptionally Precise Measurements, Maximum Repeat Accuracy

Pulse Ranging Technology (PRT) encompasses long detection ranges, high accuracy, and immunity to ambient light sources with the advantage of maximum cost-efficiency. Based on this technology, the VDM28 sensor series with a standardized housing design completes an extremely wide range of measuring and positioning tasks with exceptional reliability. The small diameter of the light spot guarantees maximum positioning accuracy and precise detection. The integrated IO-Link interface ensures standardized compatibility and simple handling.

## Highlights

- Large portfolio of switching and measuring sensors (IO-Link available) for an extremely wide range of applications
- Very high level of immunity and resistance to environmental influences
- High repeat accuracy that is unaffected by surface characteristics
- Very small diameter of the light spot ensures precise detection

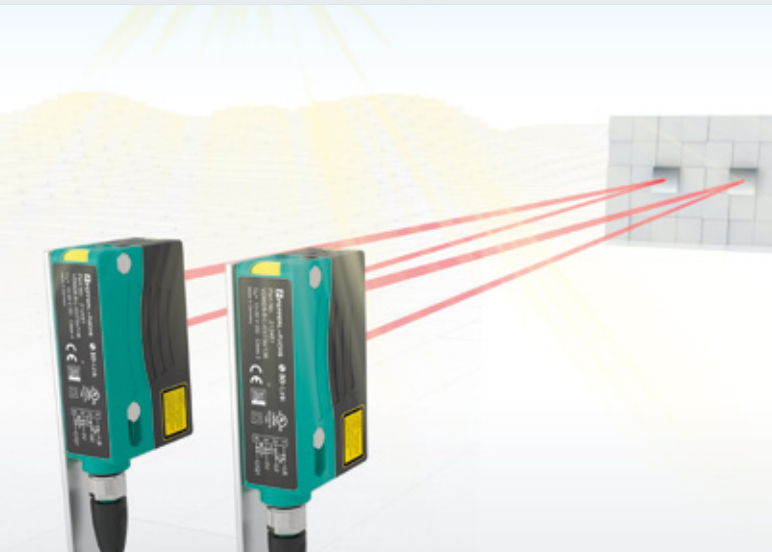

Immunity and resistance to environmental influences

Excerpt of technical data	VDM28-8*	VDM28-15*	VDM28-50*
<b>Dimensions (W × H × D)</b>	25.8 mm × 88 mm × 54.6 mm		
<b>Measuring range</b>	0.2 m ... 8 m	0.2 m ... 15 m	0.2 m ... 50 m (on reflector)
<b>Repeat accuracy</b>	< 5 mm		
<b>Interface</b>	IO-Link, push-pull output, analog output 4 mA ... 20 mA		
<b>Laser class</b>	1		



For more information, visit  
[pepperl-fuchs.com/pf-vdm28](https://www.pepperl-fuchs.com/pf-vdm28)

# An Economical and Reliable Solution

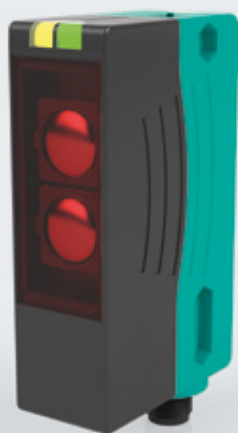

## Focused on Key Functions

The measuring sensors in the R300 series from Pepperl+Fuchs reliably complete measuring tasks using high-end Pulse Ranging Technology (PRT). The especially cost-effective design highlights the key functions of the devices. In addition to a large light spot and an innovative operating concept, the sensors offer analog outputs with 4 mA ... 20 mA or 0 V ... 10 V.

## Highlights

- Especially cost-efficient for reliable measurement tasks
- Quick switch-point adjustment via the teach-in button
- Sensing range adjuster provided via the quick-twist function
- Large light spot ensures reliable object detection and easy adjustment

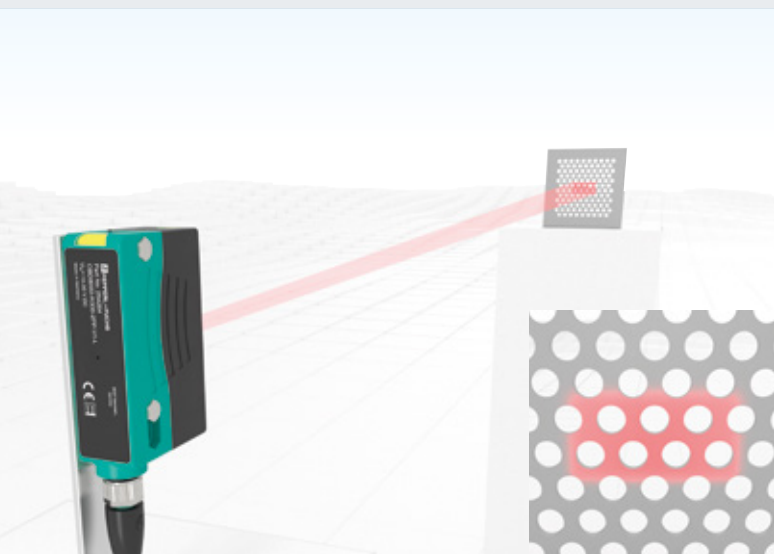

Large light spot for reliable object detection

Excerpt of technical data	OMD-8000*L	OMR-50M*
<b>Dimensions (W × H × D)</b>	25.8 mm × 88 mm × 54.3 mm	
<b>Adjustment range</b>	0.05 m ... 8 m	0.2 m ... 50 m (on reflector)
<b>Diameter of the light spot</b>	Vertical 60 mm, horizontal 30 mm at a distance of 2 m	Approx. 16 cm × 18 cm at a distance of 10 m
<b>Interface</b>	Analog output 4 mA ... 20 mA or 0 V ... 10 V, each with one push-pull output	
<b>Light emitter</b>	Laser, class 1M	Red LED



For more information, visit  
[pepperl-fuchs.com/pf-r300-om](http://pepperl-fuchs.com/pf-r300-om)

# Maximum Flexibility with Minimum Space Requirements



## Exceptionally Small Distance Sensors

Where maximum performance is required despite minimum space being available, the R10x and R20x sensor series from Pepperl+Fuchs are the ideal solutions. Five standardized device designs are available across all sensing modes. This means that the right sensor can be found for every installation and mounting scenario. The space-saving distance sensors offer multipixel technology (MPT) for exceptionally precise and accurate signal evaluation in the tightest of spaces and IO-Link interface for service and process data.

Excerpt of technical data	OMT50-R100/R101*	OMT50-R100/R101*L	OMT100-R100/R101*	OMT100-R100/R101*L	OMT150-R100/R101*L	OMT200-R100/R101*	OMT45-R103*	OMT45-R103*L	OMT100-R103*	OMT120-R103*L	OMT150-R103*	
<b>Dimensions (W × H × D)</b>	11 mm × 37.1 mm × 21.5 mm (R100) 13.9 mm × 27.3 mm × 18.3 mm (R101)						15 mm × 36.5 mm × 26.7 mm (R103)					
<b>Measuring range</b>	20 mm ... 50 mm		40 mm ... 100 mm		60 mm ... 150 mm	60 mm ... 200 mm	15 mm ... 45 mm		40 mm ... 100 mm	40 mm ... 120 mm	60 mm ... 150 mm	
<b>Resolution</b>	0.01 mm		0.1 mm				0.01 mm		0.1 mm			
<b>Repeat accuracy</b>	≤ 0.15 mm	≤ 0.1 mm	≤ 0.5 %		≤ 1 %		≤ 0.2 mm	≤ 0.15 mm	≤ 0.5 %	≤ 1 %	≤ 1 %	
<b>Interface</b>	IO-Link, push-pull output						IO-Link, push-pull output					
<b>Laser class</b>	Red LED	Laser, class 1	Red LED	Laser, class 1	Laser, class 1	Red LED	Red LED	Laser, class 1	Red LED	Laser, class 1	Red LED	



For more information, visit  
[pepperl-fuchs.com/pf-r10xr20x](https://pepperl-fuchs.com/pf-r10xr20x)

## R10x and R20x Series: All Sensing Modes in Standard Housings

Five standard designs, identical sensing modes, standardized operation, high-performance sensor technologies, and IO-Link in every version. The future-oriented product architecture of the R100, R101, R103, R200, and R201 series from Pepperl+Fuchs enable easy integration and setup with maximum efficiency and planning reliability. Find out more on pages 12–13.

Excerpt of technical data	OMT300-R200/R201*	OMT300-R200/R201*L	OMT550-R200/R201*L	OMT600-R200/R201*
<b>Dimensions (W × H × D)</b>	15 mm × 50.6 mm × 41.7 mm (R200) 15 mm × 61.7 mm × 41.7 mm (R201)			
<b>Measuring range</b>	100 mm ... 300 mm		100 mm ... 550 mm	100 mm ... 600 mm
<b>Resolution</b>	0.1 mm			
<b>Repeat accuracy</b>	< 0.5 %		< 1 %	
<b>Interface</b>	IO-Link, push-pull output, analog output 4 mA ... 20 mA or 0 V ... 10 V			
<b>Laser class</b>	Red LED	Laser, class 1	Laser, class 1	Red LED

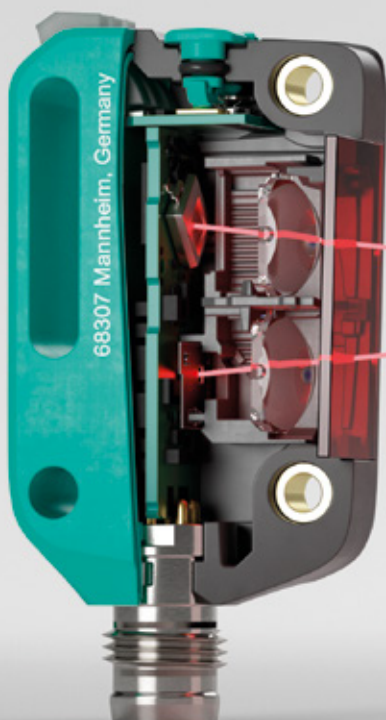

# Reliable Data Transfer in All Conditions



## Maximum Stability Even over Long Distances

Optical data couplers from Pepperl+Fuchs guarantee a constant transfer rate over the entire range at all times to provide a completely stable and reliable connection. Distances of up to 300 meters are possible, allowing use in large plants. Since the optical technology is absolutely wear-free, smooth operation is always guaranteed and the high costs of downtime are avoided. The devices are ideal for simultaneously transmitting industrial Ethernet or video streams and are compatible with all common industrial Ethernet versions.

Excerpt of technical data	LS682	LS684
Signal propagation delay	Depends on range	Constant
Detection range	0 m ... 300 m	
Light spot	1.5 m at 100 m	
Interface	Ethernet, protocol-independent	
Operating voltage	18 ... 30 VDC	



For more information, visit  
[pepperl-fuchs.com/pf-ls68x](http://pepperl-fuchs.com/pf-ls68x)



## Highlights

- Detection range of up to 300 m enables use in large plants
- Consistently high transfer rate of 100 Mbit/s for exceptionally reliable communication
- Reliable transmission from a detection range of 0 m for optimal use of space
- One-person adjustment since both reception levels are displayed on one device
- Simple installation and orientation save time and costs during commissioning

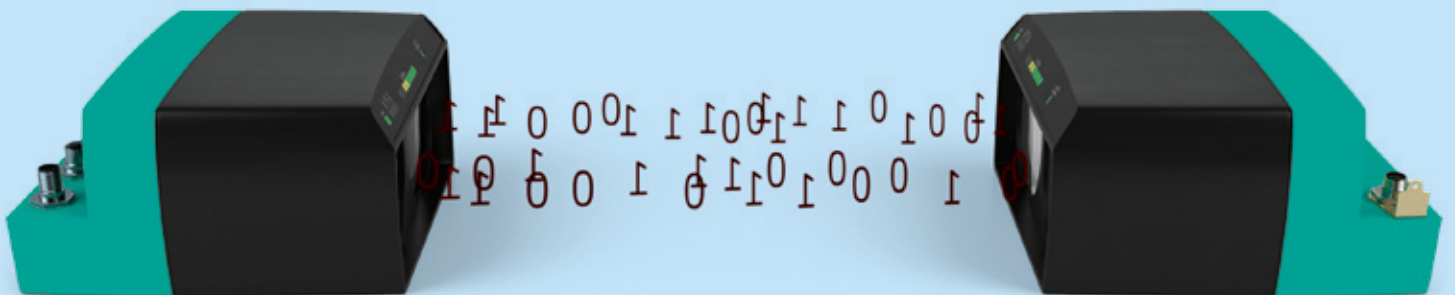

# Highest Quality Standard for Maximum Plant Availability

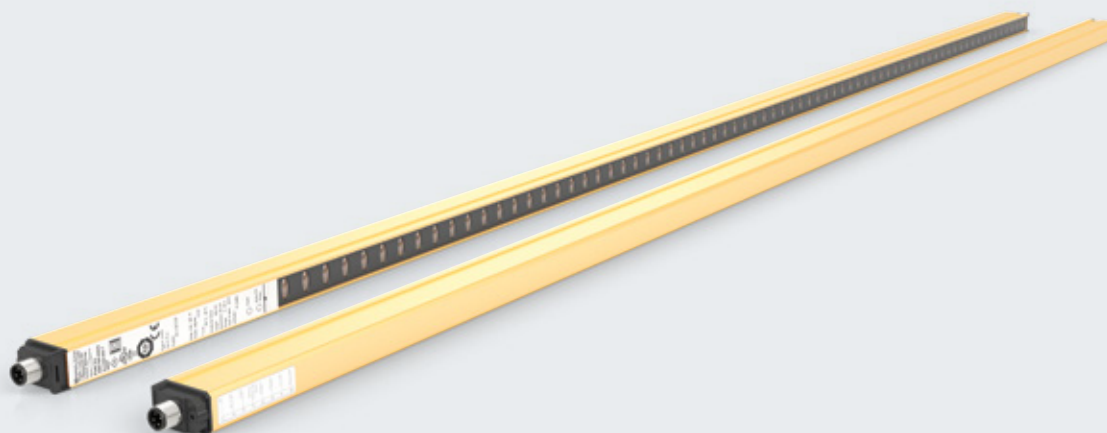

## Complete Safety at All Times

Multiray safety light barriers in the SLCT/SLCS series use redundant multiple tests during operation to prevent unwanted downtime and ensure efficient machine and plant operation. The devices generate a two-dimensional protection field with a detection capacity of 14 mm, 30 mm, 60 mm, or 90 mm, depending on the respective application requirements. Protection field heights in increments between 100 mm and 2,400 mm offer maximum flexibility for each application. In addition, the devices meet all requirements up to PL e, Cat. 4, and SIL 3 to guarantee exceptional safety and plant availability.

Excerpt of technical data	SLCT	SLCS	SLCT/35 and SLCS/35
<b>Detection capability</b>	14/30/60/90 mm		30/60/90 mm
<b>Detection range</b>	0.2 m ... 8 m	0.4 m ... 8 m	5 m ... 20 m
<b>Protection field height</b>	≤ 1,200 mm	≤ 2,400 mm	
<b>Temperature range</b>	-35 °C ... +60 °C		
<b>Degree of protection</b>	IP67, for indoor use only		
<b>Conformity</b>	PL c, Cat. 2 (SLCT), and PL e, Cat. 4 (SLCS) (EN ISO 13849); Type 2 and Type 4, (IEC 61496); SIL 1 and SIL 3 (IEC 61508); TÜV Süd, cULus, CE		



For more information, visit  
[pepperl-fuchs.com/pf-slc](https://www.pepperl-fuchs.com/pf-slc)

## Highlights

- Maximum plant availability via redundant multiple tests
- Signal evaluation is completely integrated into the extra-slim housing profile
- Slim design and dovetail guides on the sides of the housing facilitate precise, space-saving mounting in three directions
- Mirror columns for multisided protection of a machining center with minimal installation costs

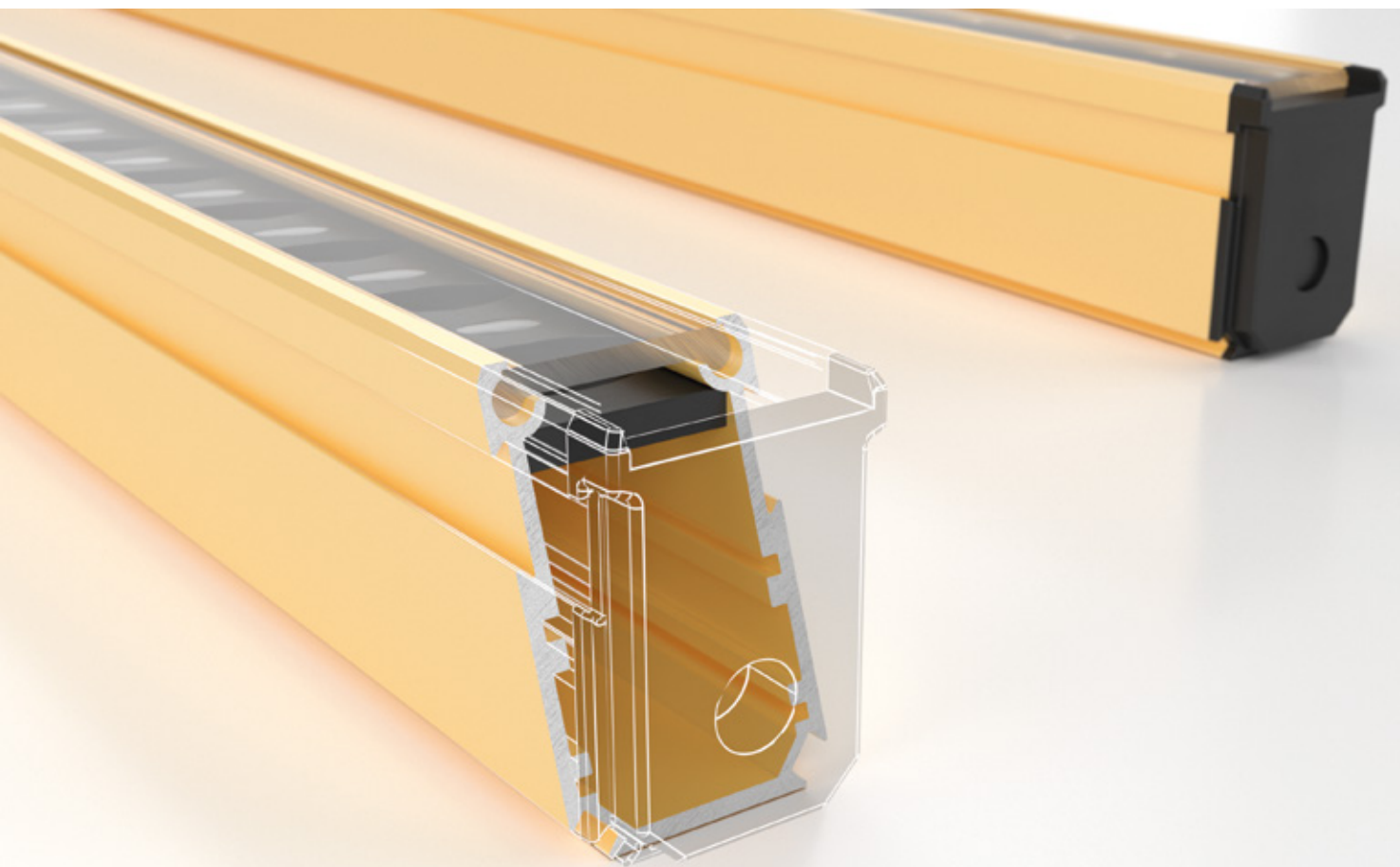

# The Perfect Addition

Only properly coordinated connection and mounting technology ensures optimal integration of a sensor. The comprehensive range of accessories from Pepperl+Fuchs supplies all the necessary components for a perfect, ready-to-install solution.

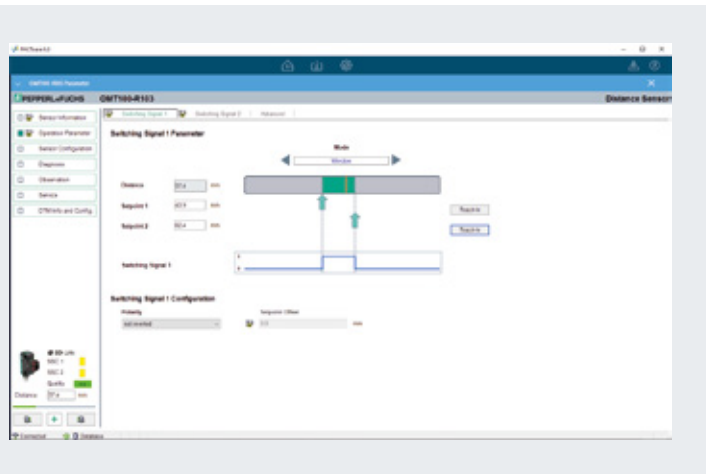

## Software for Ease of Use: PACTware

PACTware is all about straightforward and user-friendly operation. The convenient user interface, coupled with the matching device type manager (DTM), guarantees perfect visualization and allows easy configuration and parameterization of sensors.

## Software



## IO-Link Master

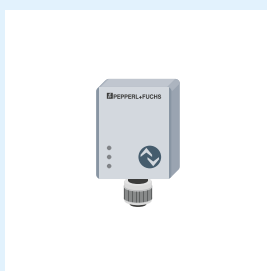

## Connectivity

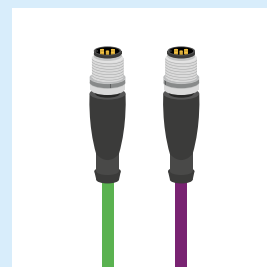
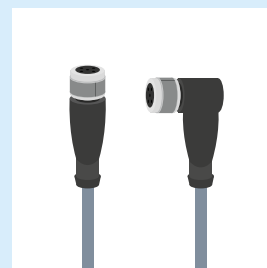
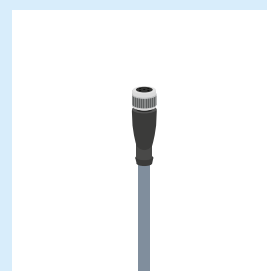

For more information, visit [pepperl-fuchs.com/pf-photo-accessories](https://pepperl-fuchs.com/pf-photo-accessories)

## Easy Integration with Customized Accessories

Alongside the PACTware operating software for visual support regarding operation and documentation of device settings, Pepperl+Fuchs offers appropriate accessories for mechanical integration. In addition to the sensor, you can obtain various fixtures, reflectors, and suitable connection technology directly from one source.

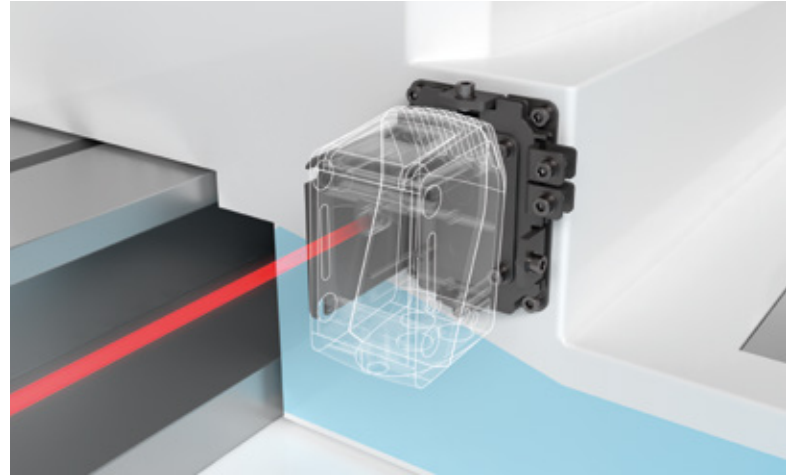

### Mounting

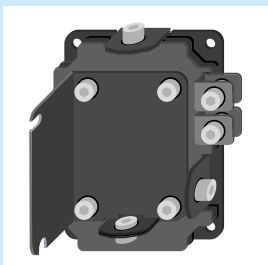
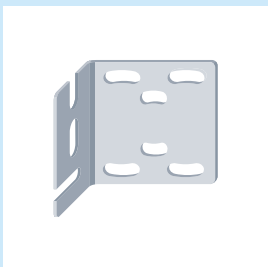

### Sensor



### Reflectors

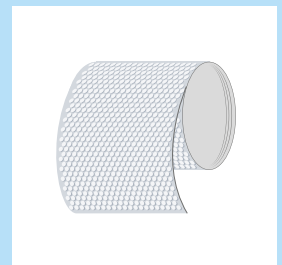



## **Our Solutions, As Individual As You.**

Automating processes often requires custom sensing solutions to ensure seamless integration. And when designing these solutions, the requirements of our customers are just as diverse as the customers themselves. Based on decades of experience and sound technical expertise, we collaborate with you to develop the perfect sensing solution.

# Customized Sensors and Systems

## Completely Customized, Seamlessly Integrable

Handing your sensing needs over to the specialists offers clear advantages: you always get a technically superior solution—quickly and with no compromises. In addition, seamless integration into existing systems and the right support are always guaranteed.

This is why Pepperl+Fuchs offers custom sensors and systems in addition to a huge standard portfolio. This ranges from the modification of existing products, such as customizing housing designs, to the collaborative development of new sensors, to the development and integration of entire sensor systems.

You get exactly what you need—technically perfect solutions for a clear competitive advantage.

## Highlights

- Best possible advice and identification of the right sensing solution
- Customer-specific solutions, from customized cable lengths to newly developed products
- Seamless system integration for perfect processes
- The right solution, no compromises

## Consulting

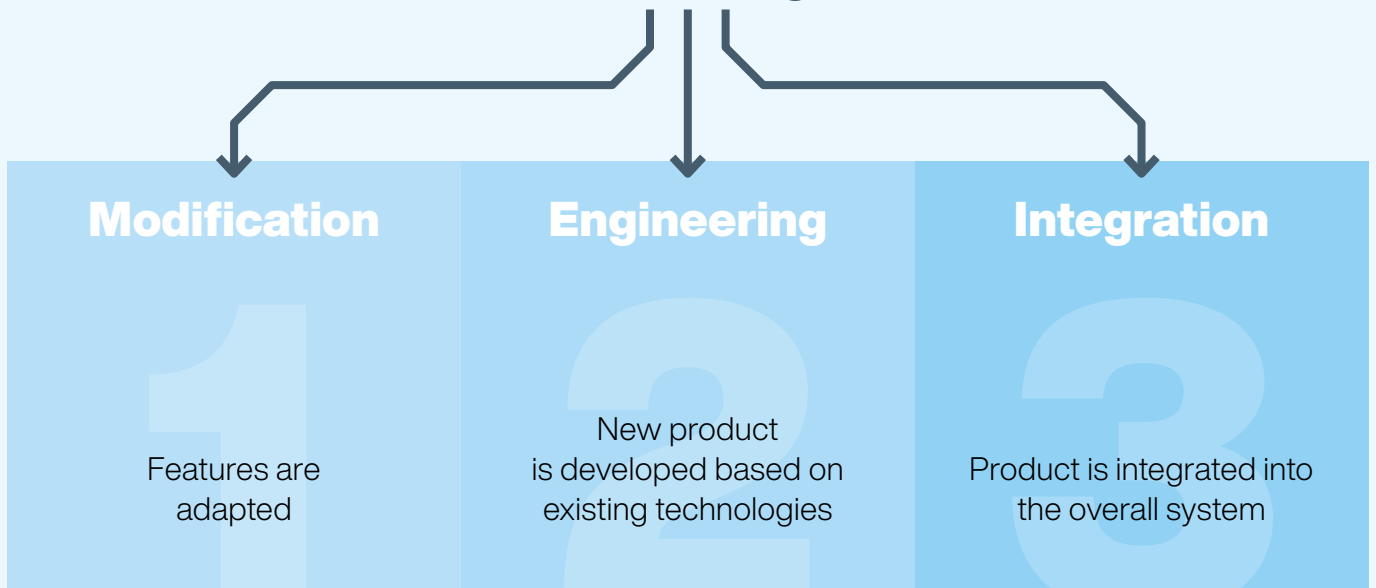

For more information, visit  
[pepperl-fuchs.com/if-solutions](https://pepperl-fuchs.com/if-solutions)

# Your automation, our passion.

## Explosion Protection

- Intrinsic Safety Barriers
- Signal Conditioners
- FieldConnex® Fieldbus Infrastructure
- Remote I/O Systems
- Electrical Explosion Protection Equipment
- Purge and Pressurization Systems
- HMI Systems
- Mobile Computing and Communications
- HART Interface Solutions
- Surge Protection
- Wireless Solutions
- Level Measurement

## Industrial Sensors

- Proximity Sensors
- Photoelectric Sensors
- Industrial Vision
- Ultrasonic Sensors
- Rotary Encoders
- Positioning Systems
- Inclination and Acceleration Sensors
- Vibration Monitoring
- Industrial Ethernet
- AS-Interface
- IO-Link
- Identification Systems
- Displays and Signal Processing
- Connectivity

[www.pepperl-fuchs.com](http://www.pepperl-fuchs.com)

Subject to modifications • © Pepperl+Fuchs  
Printed in Germany • Part. No. 039335 11/22.10 • public



**Pepperl+Fuchs Quality**

Download our latest policy here:

[www.pepperl-fuchs.com/quality](http://www.pepperl-fuchs.com/quality)